

$\varnothing 12.7_{-0.1}^0$

2 ± 0.1

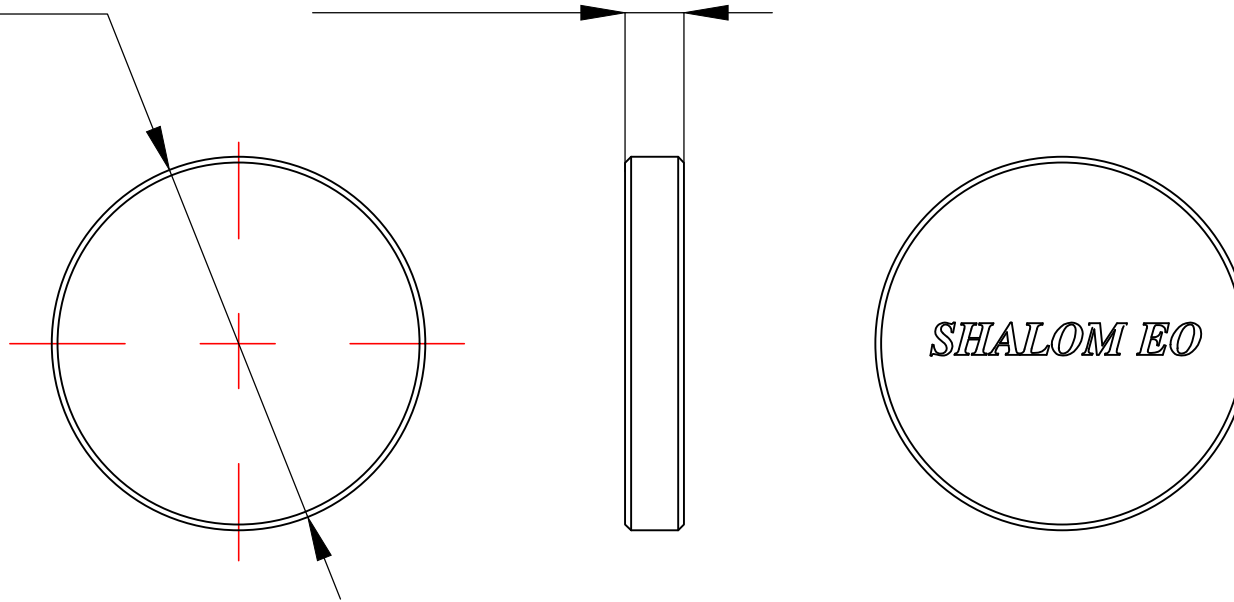

NOTES/SPECIFICATIONS:

1. MATERIALS: C7980
2. APERTURE: >90%
3. SURFACE QUALITY : 10/5 S/D
4. PARALLELISM: <10 ARC SECONDS
5. CHAMFER: 0.2mm x 45 DEGREE
6. FLATNESS: $\lambda/4$ @ 633nm
7. COATING: AR/AR@400nm~700nm(REFER TO COATING CURVES)
8. DIMENSION IN mm

**FOR INFORMATION ONLY
NOT FOR MANUFACTURING PURPOSES**

DRAWING PROJECTION			SHALOM EO w w . shalomeo . c o m			
	NAME	DATE	C7980 D12.7x2mm WINDOWS WITH AR@400nm~700nm COATING			
DRAWN	LLL	18/June/20				
APPROVAL	JT	18/June/20				
COPYRIGHT © 2020 BY SHALOM EO			MATERIAL	C7980	REV	A
			ITEM #	133-002	PROPORTION	2:1